

## HOBBIE GETAWAY PARTS

REPLACEMENT HULL - left 37010001  
 REPLACEMENT HULL - right 37020001

EZ LOC RUDDER PINTLES  
 UPPER PINTLE 90880211  
 LOWER PINTLE 90880221

ANCHOR PLATE 39100011 (PAIR)  
 SCREW 8030331

SCREW 8030171  
 SCREW (2009+) 8030331

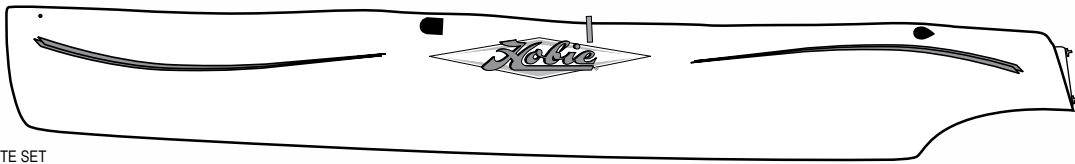

DRAIN PLUG  
 W / GASKET 10091000

DECALS -  
 37440150 "CURLS" COMPLETE SET  
 37440151 "GETAWAY" EACH  
 12451061 "Hobie" Diamond 36" Silver

BOW SPREADER 37500001

BOW TANG 20120000

END BLOCK 37500031  
 RIVET 8010201 (4)  
 BOLT 8030291  
 WASHER 8080671

BOLT 8040341  
 NUT 8050311  
 PLATE 37500021  
 RIVET 8010181



MAST STEP POST 37170001  
 MAST STEP BALL 30110001  
 WASHER 8080711  
 NUT 8050151

CLAM CLEAT 37380001

SWIVEL CLEAT 50007 DEAD  
 EYE 71220001

FWD CROSSBAR 37131910



FWD END CAP 37151041

CROSS BAR STOP PLATE 38132001  
 RIVET 8010181 (3)

REAR CROSSBAR 37191910  
 TRAVELER SWIVEL CAM PLATE 37760041  
 SWIVEL CLEAT 50007  
 REAR END CAP 37201021



CROSS BAR STOP PLATE 38132001  
 RIVET 8010181 (3)

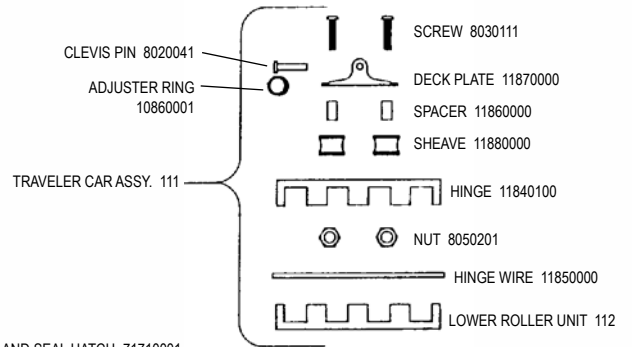

ORIGINAL HATCH 37370021\*  
 MOUNT TO HULL GASKET 37370031  
 SCREWS 8031151  
 5" HATCH (INSIDE) 41370001  
 \* Replacement "O" Ring Seal  
 # SPA-4SEAL-S Available from iintra.com  
 Not stocked by Hobie Cat

HOBBIE TWIST AND SEAL HATCH 71710001  
 GASKET 71707002 (REQ 2)  
 SCREWS 8032121 (REQ 14)  
 5" HATCH (INSIDE) 41370001  
 DRAIN ELBOW FITTING 37370036

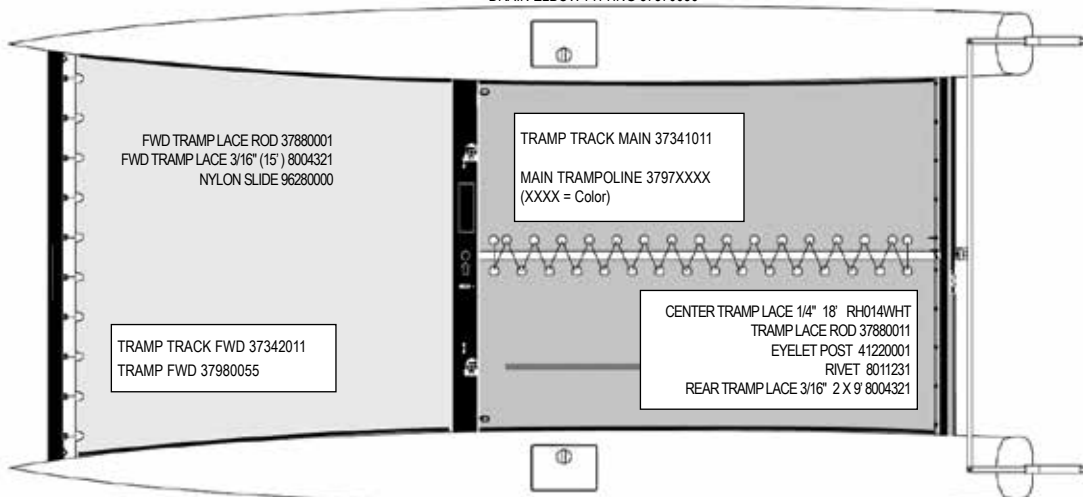

FWD TRAMP LACE ROD 37880001  
 FWD TRAMP LACE 3/16" (15') 8004321  
 NYLON SLIDE 96280000

TRAMP TRACK MAIN 37341011

MAIN TRAMPOLINE 3797XXXX  
 (XXXX = Color)

TRAMP TRACK FWD 37342011  
 TRAMP FWD 37980055

CENTER TRAMP LACE 1/4" 18" RH014WHT  
 TRAMP LACE ROD 37880011  
 EYELET POST 41220001  
 RIVET 8011231  
 REAR TRAMP LACE 3/16" 2 X 9' 8004321

FIBERGLASS EXTENSION WITH HINGE 20550001 (84")  
(GETAWAY OEM CUT TO 60")

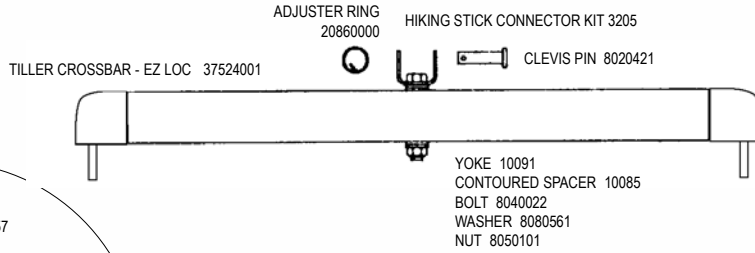

MAST ASSEMBLY 37610000

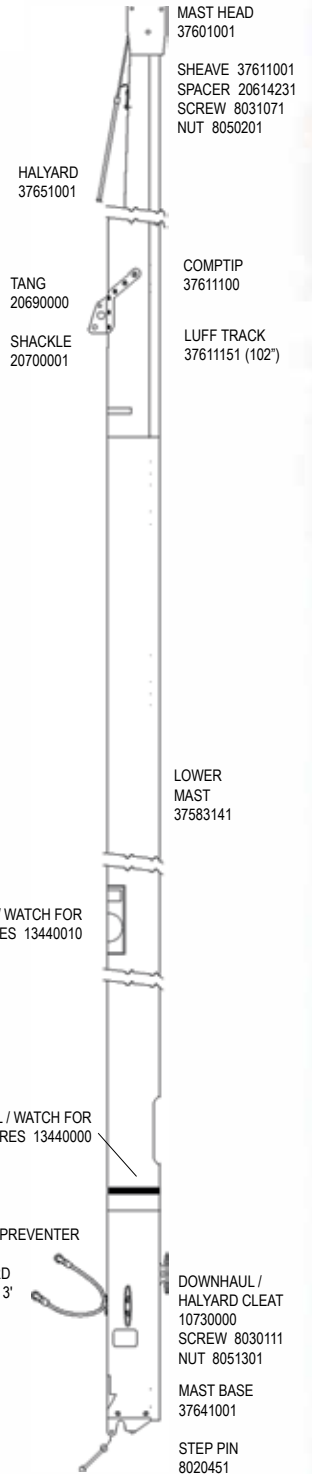

TILLER CONNECTOR 1957

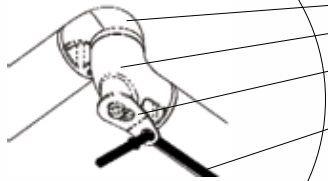

**RUDDER ASSEMBLY - EZ LOC**  
37312000

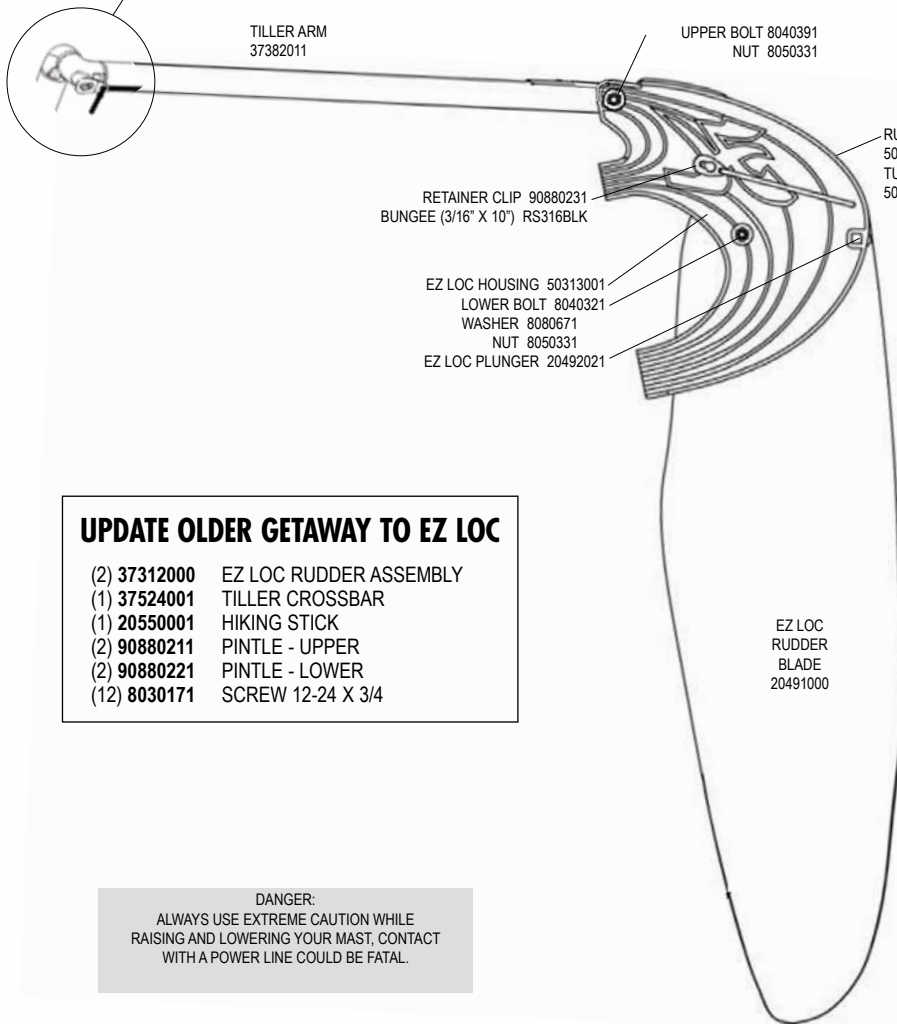

## UPDATE OLDER GETAWAY TO EZ LOC

- (2) 37312000 EZ LOC RUDDER ASSEMBLY
- (1) 37524001 TILLER CROSSBAR
- (1) 20550001 HIKING STICK
- (2) 90880211 PINTLE - UPPER
- (2) 90880221 PINTLE - LOWER
- (12) 8030171 SCREW 12-24 X 3/4

**DANGER:**  
ALWAYS USE EXTREME CAUTION WHILE RAISING AND LOWERING YOUR MAST, CONTACT WITH A POWER LINE COULD BE FATAL.



FORESTAY ASSY 37810001  
 FORESTAY ASSY INCLUDES:  
 \*SHACKLE W/KEEPER WIRE 20700001  
 \*SWIVEL 61230000  
 \*YOKE 37810030  
 \*SCREW HSPAP  
 \*LOCK NUT 8050111  
 \*LOWER FORESTAY 37810021

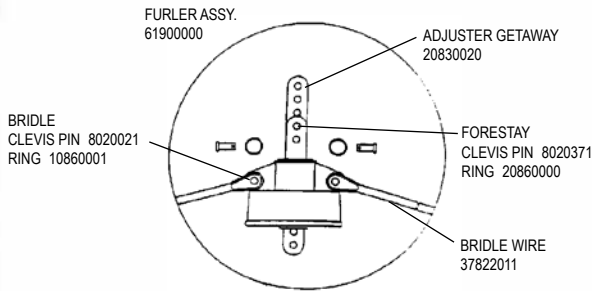

ROLLER FURLER DETAIL

**FURLER TUNE UP KIT 61900900**  
 INCLUDES: BEARINGS, BEARING CAGE, NYLINER, NYLON SLEEVE, DARBY RINGS, SPOOL, HOUSING

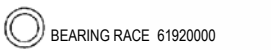
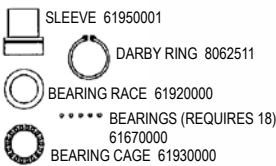
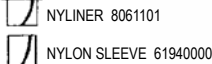
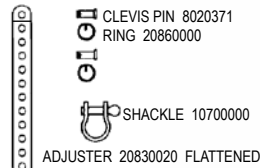

FURLER ASSY. 61900000

NOT SHOWN  
 LINE RH018WHT X 18'  
 SCREW 8030501

## SHROUDS



SHACKLE 20700001



SHROUD 37790001



CLEVIS PIN 8020381  
 RING DING 20860000

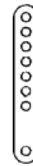

7 HOLE STAY ADJUSTER 20830010



CLEVIS PIN 8020371  
 RING DING 20860000



LEECH BATTEN TIP (TOP) 21333000



LEECH BATTEN TIP 11323000



LUFF BATTEN TIP 11322011



BATTEN TIE LINE  
 RH112WHT X 18"

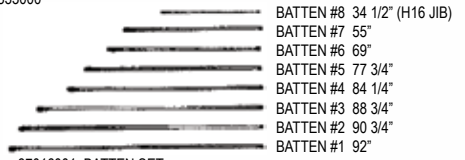

37016001 BATTEN SET  
 (FOR INDIVIDUAL BATTENS SEE UNIVERSAL BATTENS IN CATALOG)

FLOAT KIT 30119  
 SCREW 8032011



"HOBIE"  
 BATTEN LUFF  
 PROTECTOR  
 KIT 12480001

MAIN SAIL 37991XXX  
 JIB SAIL 37992XXX

SEE SEQUENTIAL PRICE LIST  
 OR SAIL COLOR SELECTION IN CATALOG

"S" HOOK 38900031  
 SHACKLE 11220000

UPPER  
 BLOCK 37900021

MAIN SHEET  
 RM038RED X 38'

LOWER  
 BLOCK 37900011  
 CAM CLEAT  
 RF5011 CAM CLEAT  
 RF5015 FAIRLEAD  
 8030241 SCREW (2)

JIB COVER 1815  
 SNAP HOOK 53790040

JIB HOOK 53790141

CLEW BLOCK 20680000

JIB SHEET RM516BLU X 32'  
 DOWNHAUL RH014WHT X 5'

RIGHTING LINE SYSTEM 30109

## MODEL / YEAR / ACCESSORY VARIATIONS

TILLER CROSSBAR 37521001 (OLDER RUDDER CASTINGS / M20 STYLE CONNECTORS)  
 TILLER CROSSBAR 37522001 (OLDER RUDDER CASTINGS / TENDON STYLE CONNECTORS)  
 TILLER CROSSBAR 37523001 (EZ LOC RUDDERS / TENDON CONNECTORS)

### OLDER TILLER CONNECTOR PARTS

#### CLUB TILLER CONNECTOR (1954 / 1956)

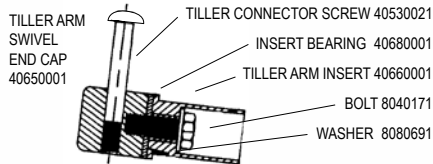

1956 KIT - CLUB TILLER CONNECTOR  
 (REPLACES TENDON STYLE WITH CLUB BOLT STYLE)  
 1954 KIT - CLUB TILLER CONNECTOR / UPGRADE FOR EARLY BOATS  
 WITH ORIGINAL CURVED TENDON CONNECTORS:  
 INCLUDES TILLER CROSS BAR AND ALL TILLER CONNECTOR FITTINGS

#### TENDON TILLER CONNECTOR

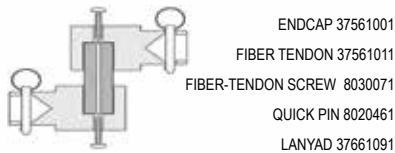

ENDCAP 37561001  
 FIBER TENDON 37561011  
 FIBER-TENDON SCREW 8030071  
 QUICK PIN 8020461  
 LANYAD 37661091

### RUDDER PARTS

Pre-"EZ LOC" Rudder System

\* = SUB ASSEMBLY PART / INCLUDED WITH CASTING

#### ALUMINUM RUDDER CASTINGS

UPPER PINTLE 38101301  
 LOWER PINTLE 38101401  
 KEEPER PIN W/ LANYARD 38490011

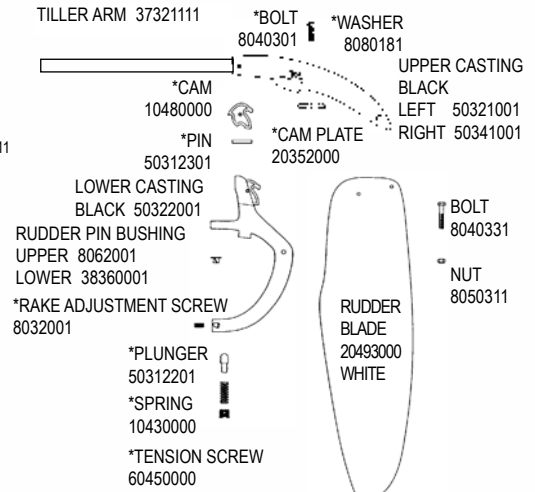

TILLER ARM 37321111  
 \*BOLT 8040301  
 \*WASHER 8080181  
 \*CAM 10480000  
 \*PIN 50312301  
 \*CAM PLATE 20352000  
 LOWER CASTING BLACK 50322001  
 RUDDER PIN BUSHING UPPER 8062001  
 LOWER 38360001  
 \*RAKE ADJUSTMENT SCREW 8032001  
 \*PLUNGER 50312201  
 \*SPRING 10430000  
 \*TENSION SCREW 60450000  
 UPPER CASTING BLACK LEFT 50321001  
 RIGHT 50341001  
 RUDDER BLADE 20493000 WHITE  
 BOLT 8040331  
 NUT 8050311

### 37001000 GETAWAY WING ASSEMBLY (WITH COVER)

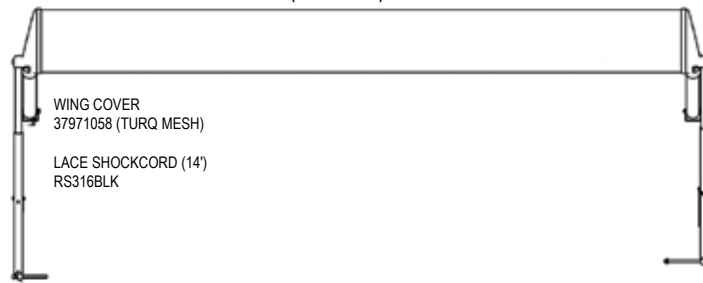

WING COVER 37971058 (TURQ MESH)  
 LACE SHOCKCORD (14') RS316BLK

### GETAWAY RIVET GUIDE

( ) INDICATES QUANTITY NEEDED TO FASTEN PART

**MAST**  
 HEAD 8010121 (2)  
 HALYLARD HOOK 8011231 (2)  
 TANG 8010121 (12)  
 8011291 (12)  
 BUNGEE PAD EYE 8010181 (2)  
 8011291 (2)  
 HALYARD CLEAT 8010121 (2)  
 8011291 (2)  
 BASE 8010131 (4)  
 8011291 (4)

**BOW SPREADER BAR**  
 PLATES, BRIDLE BOW TANG 8010181 (4)  
 INTERNAL STIFFENER 8010201 (4)

**MAIN CROSSBAR**  
 BEAM STOP PLATES 8010181 (6)  
 CLEAT 8010181 (1)  
 PADEYES 8010181 (4)  
 JAM CLEAT 8010131 (1)  
 CLEATS, SWIVEL 8010131 (6)  
 PADEYES 8010131 (4)  
 END CAPS 8010201 (10)

**REAR CROSS BAR**  
 PADEYE 8010181 (2)  
 BEAM STOP PLATES 8010181 (6)  
 CLEAT PLATE 8010131 (4)  
 TRAMP LACE POSTS 8011231 (10)  
 END CAPS 8010201 (8)

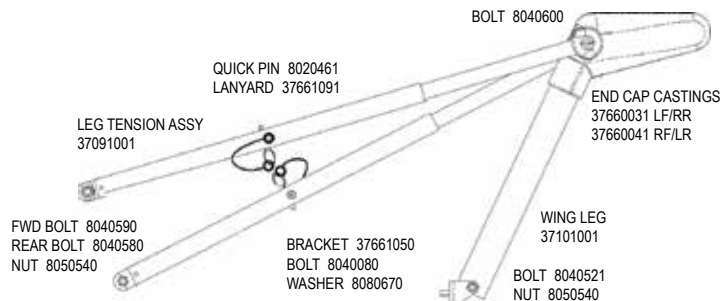

BOLT 8040600  
 QUICK PIN 8020461  
 LANYARD 37661091  
 LEG TENSION ASSY 37091001  
 FWD BOLT 8040590  
 REAR BOLT 8040580  
 NUT 8050540  
 BRACKET 37661050  
 BOLT 8040080  
 WASHER 8080670  
 WING LEG 37101001  
 END CAP CASTINGS 37660031 LF/RR  
 37660041 RF/LR  
 BOLT 8040521  
 NUT 8050540