

VAGO

Rigging Manual

- 1** Glossary
- 2** Useful Boat Terminology
- 3** Sail Number Positioning
- 4** Rigging and Raising the Mast
- 5** Boom and Cnav
- 6** Sails
- 7** Lower Shroud Tensioning
- 8** Gennaker
- 9** Mainsail - Standard and Race
- 10** Outhaul
- 11** Cunningham
- 12** Single Line Reefing
- 13** Single Line Reefing Instructions
- 14** Single Line Reefing Method
- 15** Rudder
- 16** Launching and Basic Safety on the Water

Vago Rigging Instructions

This guide contains instructions for rigging your Vago. Due to production supplies certain parts may be different from those shown in description, color, and specification. LaserPerformance reserves the right to change specifications without prior notification.

Important information

There are three hatches and one transom drain bung on the Vago. All hatches and the drain bung should be checked every time you sail to ensure they are tight and fit correctly.

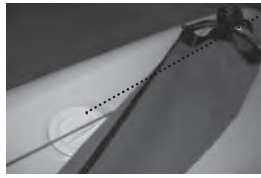

1. Under the gennaker sock on the port side

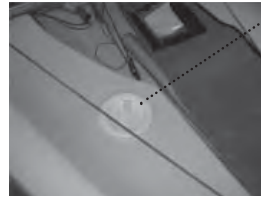

2. On the starboard foredeck

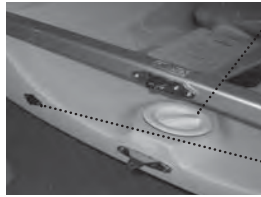

3. On the aft deck

Note: Also check that the rear bung is hand tight.



Example of INCORRECT hatch fitting

1. Glossary

Aft: Rearward
Batten: A thin stiffening strip in the sail to support the leach
Boom: Spar at the bottom of the mainsail
Bow: Front of the boat
Burgee: Wind direction indicator (usually a small flag)
Clew: Back lower corner of a sail
Cleat: A fitting used for holding/securing ropes
Cunningham: Purchase system for tightening the forward edge/luff of the sail
Foot: Bottom edge of the sail
Fore: Forward
Forestay: The wire supporting the mast at the bow of the boat
Gennaker: Performance cut downwind sail
Gnav: Purchase system for tightening the rear edge/leach of the sail
Gudgeon: Fitting on the transom and rudder used to hang rudder
Gunwale: The outermost edge of the boat
Halyard: A rope or wire used to lower or hoist sails
Head: Top corner of sail
Jib: Front sail
Leach: Rear edge of the sail
Luff: Forward edge of the sail
Mast: Main vertical spar supporting the rig/sails

Mast Heel: Bottom edge/foot of the mast
Mast Step: Integral tube where the mast heel/foot of the mast is located
Outhaul: Purchase system for tightening the bottom edge/foot of the sail
Rudder: Blade and attachments used for steering the boat
Sheet: Rope for controlling the inward/outward position of the sail
Shrouds: Pieces of standing rigging that hold the mast up from side to side and connect at the top of the mast; additional shrouds connect partway down the mast and terminate at their bottom ends to the side of the boat; they are attached symmetrically on both the port and starboard sides
Spar: a round, elliptical or box section shaped pole, typically made of aluminum to which the sail(s) attaches
Spreaders: Metal struts placed in pairs to support the mast side ways and control the bend in the mast
Stem fitting: Stainless fitting at the bow to which the forestay attaches
Stern: Back of the boat
Tack: Forward lower corner of the sail
Vang: Purchase system for tightening the rear edge/leach of the sail

2. Useful Boat Terminology

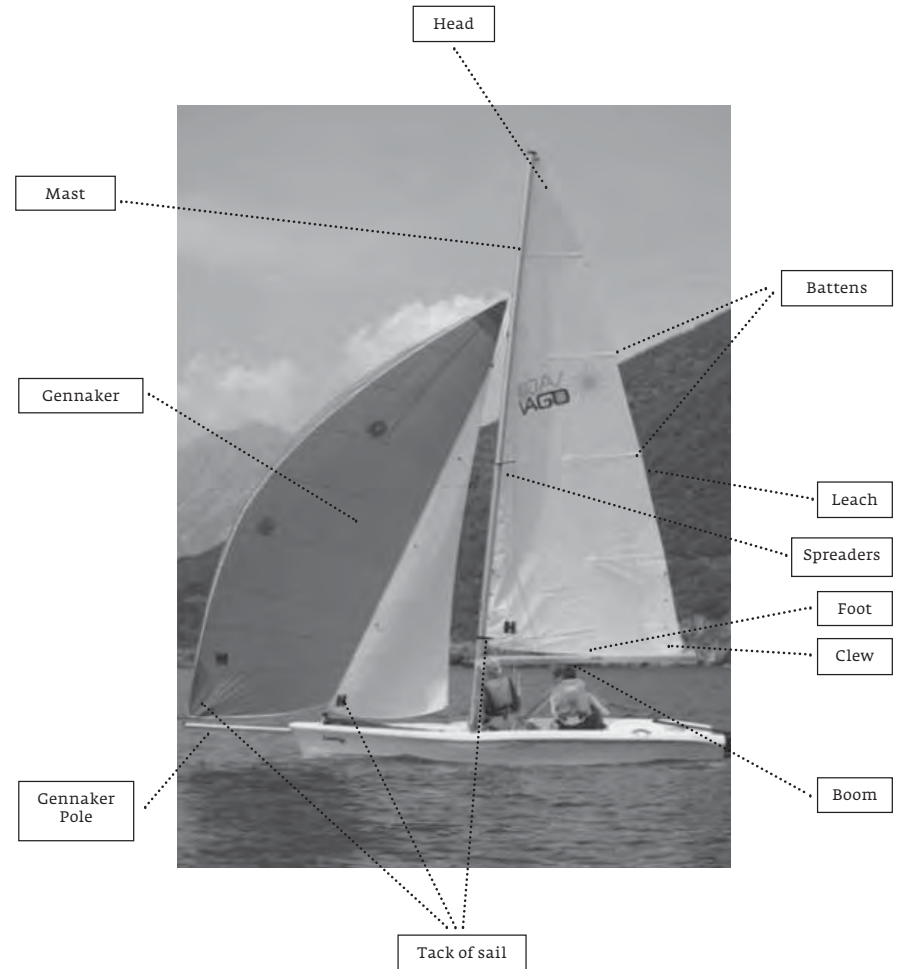

3. Sail Number Positioning

It is advised to apply the sail numbers in a dry, clean and wind free environment.

Standard Sail



figure 1

1. Lay the sail on a flat surface, starboard side up. (figure 1)
2. The numbers on the starboard side are always higher than the port side.
3. Measure 60 mm down, from the seam directly below the logo.
4. Mark a line, parallel to the seam. Mark a line using a pencil or washable pen.
5. Measure 100 mm in from the leach on this line.
6. The first number is positioned 100 mm in from the leach and with the top of the number on the line parallel to the seam.
7. The numbers are 60 mm apart.
8. Turn over the sail and position the port numbers 60 mm below the top seam of the panel below. The numbers should be positioned parallel to the seam.

Race Sail



figure 2

1. Lay the sail on a flat surface starboard side up. (figure 2)
2. The numbers on the starboard side are always higher than the port side.
3. Measure 200mm down, from the second batten pocket from the bottom of the sail.
4. Mark a line parallel to the batten pocket. Use tape
5. Measure 100mm in from the leech on this line.
6. The first number is positioned 100mm in from the leech and with the top of the number on this tape line
7. The numbers are 60mm apart.
8. Turn over the sail and position the port numbers 60mm below the starboard numbers and parallel to them.

4. Rigging And Raising The Mast

1. Unwrap the mast.
2. Ensure all the halyards are led to the base of the mast and each halyard rope end has a knot tied in it. (figure 3)
3. Insert blanking plugs, (tight fit to produce seal) a medium size flat blade screwdriver maybe required to fit. (figure 4)
4. If applicable, fit trapeze wires and plugs in the top terminal positions on the mast. (Note: Trapeze kit is an optional upgrade for the Vago, but included with the Vago Race). (figure 5)
5. Fit spreaders. (See next page for diagram). (figure 6)
6. Ensure that all the spreader pins and rings are taped up or serious damage could occur to the sails. (figure 7a) (figure 7b)

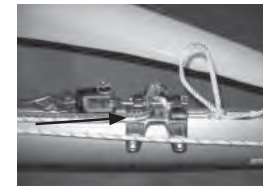

figure 3

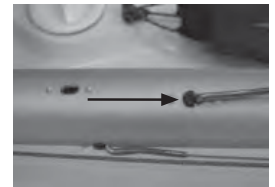

figure 4

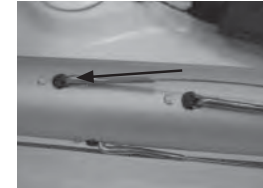

figure 5



figure 6



figure 7a



figure 7b

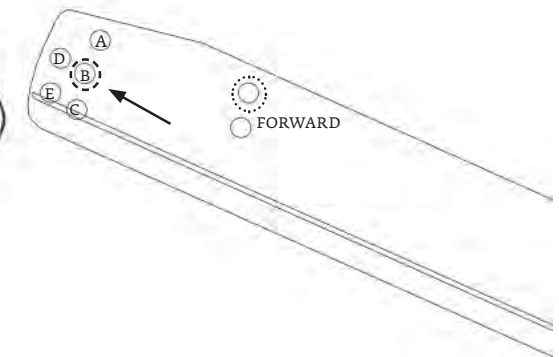
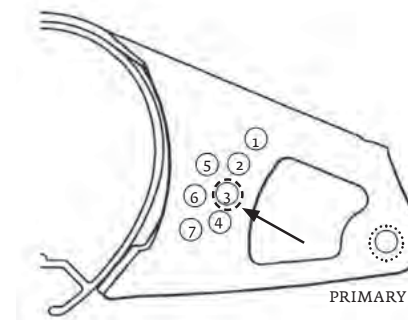

Attachment of Spreader.

Primary Pin: 
Fit down through the bracket's Primary hole and the Forward spreader hole.

Adjuster Pin: 
Fit down through bracket adjuster hole 3, and through spreader adjuster hole B.

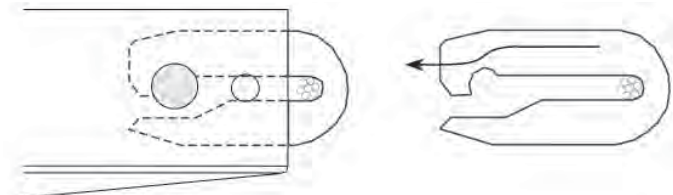

Spreader Ends

Remove the clevis pin and slide out the spreader end hook. Slide the hook over the shroud, and slide back into the spreader. Refit the clevis pin and split ring.

Security

All clevis pins must be fitted with the flat head on top, and locked with a split ring. Tape all split rings, pins and the outboard end of the spreader extrusion. This will reduce chafe on the mainsail and prevent flailing sails/halyards becoming damaged. Self-amalgamating tape is best, but PVC electrical tape is an adequate alternative.

| Class | Bracket Connection Pin | |
|------------|------------------------|----------|
| | Primary | Adjuster |
| Laser Vago | Fwd | 3B |

7. Raise the mast and position the mast heel on the mast step. The mast heel recess/slot should straddle the bolt in the mast step. (figure 8) **(Note - This is a two person operation as someone will need to hold the mast upright while shrouds and forestay are connected - Ensure that there are no overhead power cables)**

8. Attach the shrouds to the shroud anchor point with the adjuster pin position in the 4th hole down on the back of the vernier adjuster. (figure 9a) (figure 9b)

9. Temporarily attach the forestay around the jib tack bar (not the furling drum). (figure 10)

10. Shackle the lower shrouds to the shroud anchor points ensuring that a multiple thickness line stop of approximately 125 mm in rigged length is used between the shackle and the hard eye in the end of each lower shroud wire. The shackle should be positioned between the stay adjuster and the ratchet block. (The ratchet block should always be at the front). (figure 11)

11. Loosely fasten the other end of the lower shroud wires to the eye on the front face of the mast using multiple thickness line stopps.

(Note: lower shroud tension is adjusted using these line stopps after the jib halyard has been tensioned). (figure 12)



figure 8



figure 9a



figure 9b



figure 10

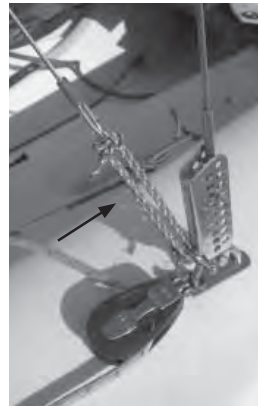

figure 11



figure 12

12. Attach the trapeze rings to hull mounted shockcords by feeding the elastic loop through the ring at the bottom of the pulley. **(Note: Trapeze kit is an optional upgrade on the standard rig but is included in the Race rig).** (figure 13)

13. Place the loop of elastic shockcord over the metal trapeze ring and pull tight. (figure 14)

14. **Tip:** Tie two double half hitch stopper knots in the adjuster line (a hand width apart). (figure 15)

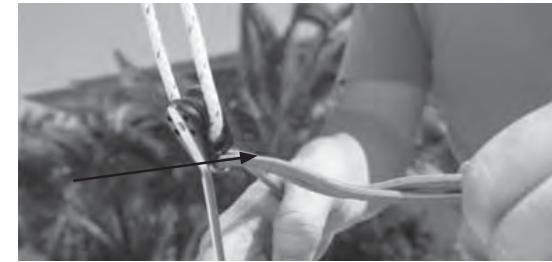

figure 13

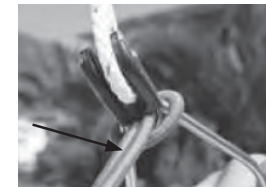

figure 14



figure 15

5. Boom and Gnav

1. Unpack the boom and Gnav tackle. (figure 16)

2. Attach the boom to the mast using the drop nose pin. (Articulating toggle at the bottom). (figure 17)

3. Tie the Gnav control line from the boom to the double block and becket at the base of the mast the boat. (figure 18)

Tip: Best practice is to use a bowline.

4. Attach the Gnav strut to the Gnav anchor point using the drop nose pin. (Articulating toggle at the bottom with joint orientation as shown). (figure 19)

5. Thread the mainsheet through the center of the block attached to the bridle rope and tie a half hitch stopper knot. (figure 20)

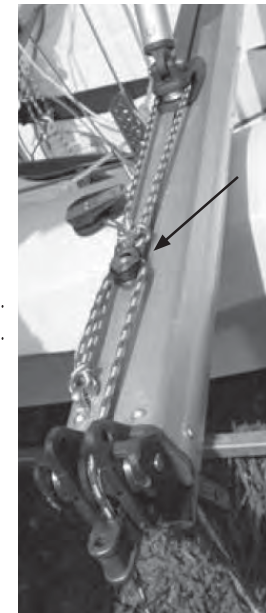

figure 16



figure 17

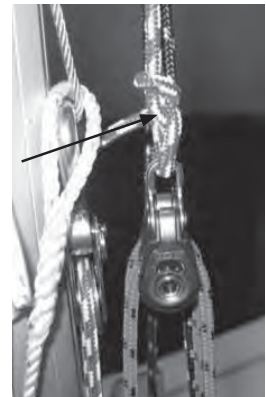

figure 18



figure 19



figure 20

6. Feed the mainsheet through the blocks and to the mainsheet jammer as shown. (figure 21)

Tip: double check that the mainsheet passes through the switchable ratchet in the correct direction. (figure 22)

Tip: tie the loose end of the mainsheet to one of the rear toe straps to prevent the sheet from flogging and falling overboard. (figure 22)

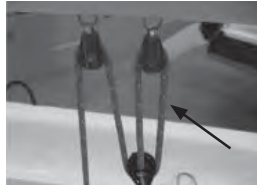

figure 21



figure 22



figure 23



figure 24

6. Sails

1. Ensure furling drum line is fully wound completely onto furling drum before you attach the jib. (figure 23)

2. Unroll the jib and attach jib tack to furling drum. Tape up pins on jib tack. (figure 24)

3. Attach the head of the jib to the jib halyard furling swivel and tape up prior to hoisting. (figure 25)

4. Hoist jib by pulling the white halyard out of aft face of the mast then hook the jib halyard purchase system onto jib halyard wire. (Ensure hook is facing aft). (figure 26)



figure 25



figure 26

5. Tension the jib halyard purchase system until the jib luff wire is taught. Cleat and tidy the rope end in the pocket on the underside of the gennaker sock. (If a loose gauge is used to measure the rig tension do NOT exceed 15 units or 70 kgs - measured on the shroud 0.75 meters above the vernier adjuster). (figure 27)



figure 27



figure 28

6. Attach the center of the jib sheet to the jib clew. (figure 28)

7. Thread the free ends of the jib sheet through the swivel jib fairlead cleats on the outer ends of the front beam. (figure 29)

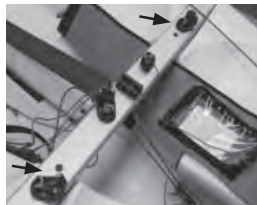

figure 29



figure 30

Tip: tie the sheet ends together to prevent flailing and prevent sheets from falling overboard. (figure 30)

8. Remove the forestay from the jib tack band tie to the P clip at the bottom of the mast on the starboard side. (figure 31)



figure 31



figure 32

9. Furl the jib by pulling the furling line. The furling line cleat is positioned on the front beam on the port/left hand side. (figure 32)

7. Lower shroud tensioning

After tensioning the jib halyard, readjust the lower shrouds so that they are just tight. **It is essential that the mast is straight** before the mainsail is hoisted (fore and aft and side to side). Lower shroud tension should be adjusted accordingly. (figure 33)



figure 33

8. Gennaker

1. Temporarily tie the gennaker halyard to one of the lower shrouds. (Blue halyard exiting from $\frac{3}{4}$ height up mast, just above the jib halyard sheave box).

2. Ensure the end of the gennaker halyard taken from the base of the mast is free of knots and tangles. (figure 34)

3. Take the gennaker halyard from the base of the mast and pass forward, under the gennaker sock and round the gennaker pole outhaul block. (The gennaker pole outhaul block is attached to the blue rope led from the pole as shown in the picture). (figure 35)



figure 34



figure 35

4. Thread the halyard aft and through the gennaker halyard cleat on the starboard /right hand side of the front beam. (figure 36)



figure 36



figure 37

5. Pass the halyard to the port side of the boat and thread it through the block at the aft end of the gennaker sock. (figure 37)

6. Tie the end of the halyard to something such as a batten or tiller extension and carefully pass the end of the halyard up the sock until you can grasp it from the front end of the gennaker sock opening. (figure 38)



figure 38



figure 39

7. Tie this end of the halyard temporarily around the jib tack bar and remove the batten/extension from the sock.

8. Unfold the gennaker

a. Identify the tack (written on the sail).

b. Secure the gennaker pole tack line to the sail using a bowline. (The tack line comes out of the front of the gennaker pole).

c. The plastic bobble should be between the sail and the pole end. (figure 39)

9. Untie the gennaker halyard from the lower shroud and secure it to the head of the gennaker using a bowline. (figure 40)



figure 40

a. Pass the downhaul end of the gennaker halyard through the lower downhaul patch ring on the port side of the sail. (figure 41)



figure 41

b. Secure the gennaker halyard to the upper downhaul patch using a bowline. (figure 42)



figure 42

10. Attach the center of the gennaker sheet to the clew of the gennaker. (figure 43)



figure 43

11. Pass the free ends of the gennaker sheets aft (one sheet either side of the jib luff) and through the gennaker sheet ratchet blocks attached to the shroud anchor points. There are arrows on the ratchet block to indicate which way the rope should pass. When under load, the ratchet will engage. (figure 44)



figure 44

Note: The sheets must pass forward of the shrouds at all times.

12. Tie the free ends of the gennaker sheet together. (figure 45)



figure 45

13. Ensure the boat is pointing directly into the wind and hoist the gennaker. Take great care to ensure that the gennaker does not get snagged around the trolley/dolly; a second person should help with this to ensure it does not snag anywhere. Check the gennaker is not twisted and the sheets are not tangled with the halyard. **ALWAYS TAKE GREAT CARE TO PULL UP THE GENNAKER SLOWLY AND DO NOT KEEP PULLING IF IT BECOMES TANGLED OR TIGHT.** (figure 46)



figure 46

14. Unclear the halyard and gently pull the gennaker into the sock by pulling the halyard through the block at the aft end of the sock. A second person should help with this and be positioned at the front of the boat to ensure the gennaker does not get snagged anywhere.

9. Mainsail – Race and standard sail

1. Remove the mainsail from the bag and unroll. (figure 47)



figure 47

2. Ensure all battens are tight in their pockets and the velcro locking mechanisms are positively engaged:

a. To release the tension from a batten, slide the batten prodder (supplied) carefully between the two halves of the velcro locking mechanism and pull the retrieval line slowly (figure 48)

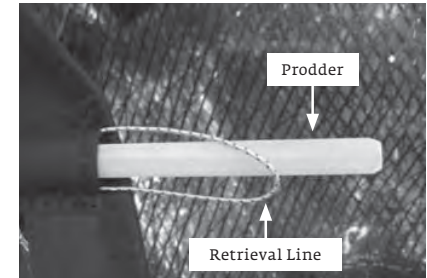

figure 48

b. To adjust the tension on the batten, place the tip of the prodder into the location point at the end of the velcro strip then insert between the batten and the batten pocket inner side. (figure 49)

Push the prodder until the desired batten tension is attained then withdraw the prodder gently while pressing both sides of the batten pocket together to engage the velcro locking mechanism.

3. Position the boat so that it is head to wind – bow into the wind.

4. Place the mainsail in the cockpit of the hull with the luff closest the bow (front) and the leach closest the stern (back).

5. Take the main halyard:

a. Ensure there is no twists in the halyard and it is clear of the spreaders.

b. Form a loop in the end of the halyard; pass the loop through the eye in the head of the mainsail. (Pass loop from starboard/right to port/left side).



figure 49

c. Pass the bobble through this loop and pull tight to secure. (Ensure the bobble is positioned on port/left side as shown – this ensures the bobble will not get caught in the “V” between the Cnav bar and the mast during hoisting). (figure 50)



figure 50

6. Locate the head of the mainsail into the mast track. The Gnav bar must be on the starboard side of the sail with sail and halyard to the port side of the Gnav bar. (figure 51)



figure 51

7. Hoist the mainsail using the main halyard which exits the mast on the lower port side.

Note: Hoisting the mainsail is a two person operation as assistance will be required to feed the mainsail into the mast track while the other person hoists using the halyard (This will prevent the sail from pulling out of the track and jamming which could cause luff rope damage).

8. When the mainsail is fully hoisted, coil the halyard and store it in the halyard bag on the underside of the genaker sock. (figure 52)



figure 52

10. Outhaul

1. Secure the velcro tack around the mast. (figure 53)

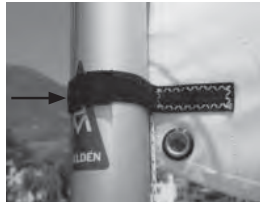

figure 53

2. Feed the plastic slug slide on the clew outhaul to the cut out on the top of the boom. (figure 54)

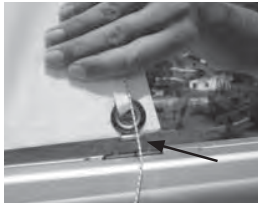

figure 54

3. The outhaul line (blue) is then passed through the eye in the sail (From port/left to starboard/right side) and anchored on the starboard/right side with a simple knot located in the slot formed in the boom end casting. (figure 55a) (figure 55b)



figure 55a



figure 55b

4. Outhaul tension is controlled using the blue rope, cleat and fairlead at the forward end of the boom. (figure 56)

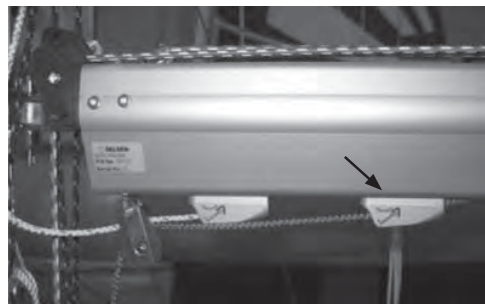

figure 56

11. Cunningham

1. Pass the rope at the end of the cunningham purchase system through the eye at the bottom of the mainsail luff (from starboard/right hand to port/left hand side).



figure 57

2. Anchor the end of the cunningham purchase system by sliding a half hitch knot into the mast track just below the gooseneck. (figure 57)



figure 58

3. Cunningham tension is controlled using the blue rope cleat and fairlead block on the top of the centerboard case on the starboard/right hand side of the boat. (figure 58)

12. Single Line Reefing

1. Rig the single line reefing.

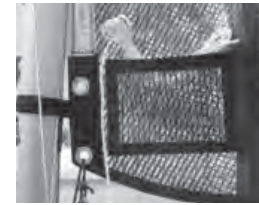

figure 59

2. Although single line reefing is only applicable to the standard Vago, you will find a pocket at the forward end of the foot of both standard and Race mainsails (port side) to tidy the loose end of the single line reefing system. (figure 59)

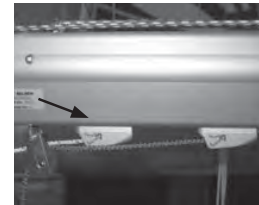
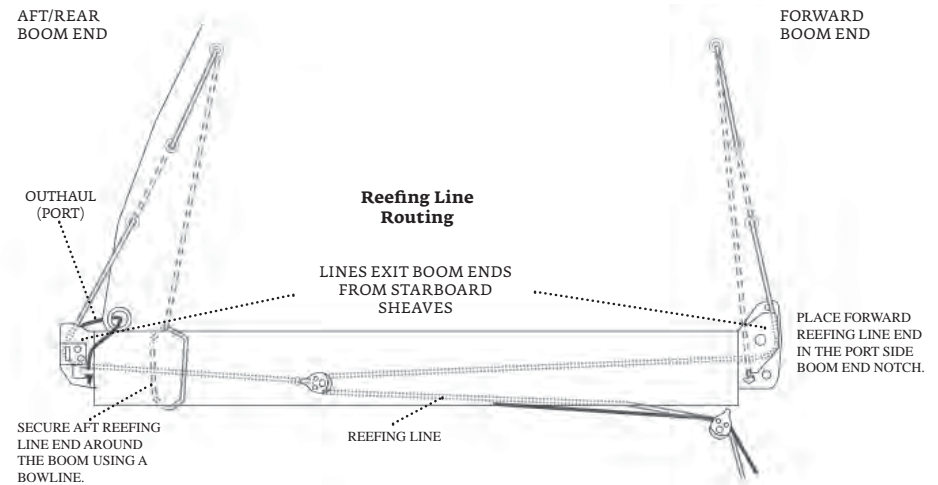

figure 60

3. Single line reefing tension is controlled using the white rope, cleat and fairlead at the forward end of the boom. (figure 60)

13. Single Line Reefing Instructions



14. Single Line Reefing Method

1. Ease sheet & Gnav (see next page for diagram).
2. Pull the reefline. The boom will angle up until all of the aft reefing line slack is taken in or Gnav travel limit is reached.
3. Ease the halyard, and continue pulling the reefline. The boom outer end will move down towards horizontal.
4. When the reef line has pulled the clew and tack down hard, cleat it off.
5. Adjust the tension on the halyard and adjust the Gnav and sheet.

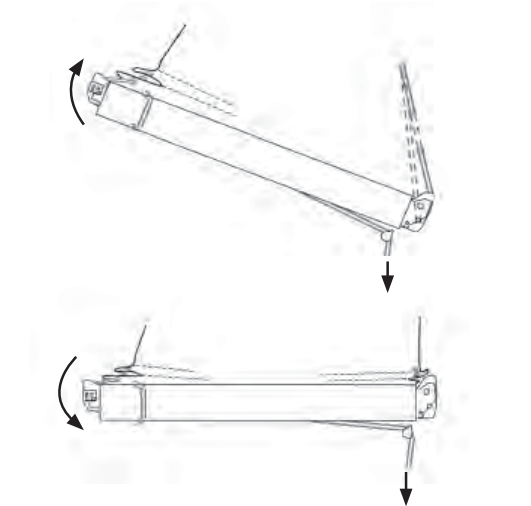

15. Rudder

1. Attach the rudder assembly to the transom - **Fit the rudder retaining split rings to the holes in both pins.** (figure 61)
2. If the boat is to be used at an institution, it may be advantageous to rig up an additional safety leash line as shown. (Two miscellaneous lengths of short rope are supplied in the storage pocket of your Vago). (figure 62)



figure 61



figure 62

Your Vago Is Now Ready For Launching.



16. Launching and Basic Safety on the Water

Before You Go Sailing:

1. Check you are wearing suitable clothing and safety equipment for the conditions and time of year.
2. Always wear a buoyancy aid or life jacket.
3. Make sure a third party knows where you are sailing and how many of you are sailing.
4. Check the weather forecast.
5. Check the time of high and low tides if applicable.
6. Seek advice on the local conditions if you are sailing in a new area.
7. Always check the condition of your craft before setting off.
8. **Check for overhead cables when rigging, launching and recovering.**
9. The use of a LaserPerformance supplied Vago mast head float is highly advisable. (This device will assist in the prevention of complete inversion in the event of capsizing).

Launching

1. Raise the mainsail with the boat facing into the wind.
2. Launch the boat using the appropriate launching trolley/dolly.
3. Take the boat into the water with the bow facing into the wind.
4. Ensure that there is enough water to float the boat off the trolley/dolly.
5. One person should hold the boat while the other gets in and prepares to set off.
6. When there is enough water below you, lower the centerboard and rudder fully.
7. Cleat the rudder downhaul in the cleat on the tiller and ensure that the wing nut on the side of the rudderstock is tight.
8. The hook at the back of the centerboard case should be attached to the centerboard rope handle when sailing.
9. The centerboard hook should be removed before coming ashore.

The rudder and centerboard should be in the fully down position at all times when sailing an asymmetric boat such as the Vago.

On The Water

1. Conform to the sailing rules of the road.
2. Look out for changing weather conditions.
3. Never sail beyond your ability or that of your crew.
4. Be competent in your sailing skills and righting techniques.

Warning: When wearing a trapeze harness, take particular care when climbing on to the centerboard and back in to the boat after capsizing. (As the trapeze harness hook could easily damage the various surfaces).

LaserPerformance equips our Vago with the highest quality parts available. We partner with key suppliers to develop top-of-the-line dinghy equipment so your boat will perform at the highest level possible when sailed with the factory supplied rope, sails and hardware. Shop online at laserperformance.com or at an authorized LaserPerformance dealer to be sure you are getting genuine LaserPerformance parts and accessories. Visit www.laserperformance.com to find your local dealer.



Care, Maintenance and Service of your LaserPerformance Product

Before rigging your Vago, please read and familiarize yourself with the rigging manual. Failure to adhere to these guidelines could invalidate your warranty.

Maintenance

- Keep the equipment clean by frequently flushing with fresh water. In corrosive atmospheres, stainless parts may show discoloration/brown staining around screw holes and rivets. This is not serious and can be removed with a fine abrasive.
- Excess water should be removed from the hull.
- Ropes, rigging and fittings should be checked at regular intervals for wear and tear, including winch gear.
- All moving parts should be lightly lubricated to avoid jamming, i.e., McLube, dry Teflon or a dry silicone based spray. Do not use oil.
- Inspect shackles, pins and clevis rings and tape up to stop snagging sails, ropes and clothing and to prevent them from coming undone.
- When refastening screws do not over tighten as this may strip the thread and do not reuse Nyloc nuts more than three times.
- Damaged or worn parts should be replaced.
- Sails should be thoroughly washed down with fresh water, dried and stored in a dry place.

Trailers and Trolleys/Dollies

- It is highly recommended that a trolley/dolly is used to launch and recover your boat. Dragging your hull up onto a beach or slip way will wear away the gel coat or polyethylene and damage the boat. Also, the hull should not be left on a pebble beach as the hull skin could be dented.
- Trailers should be rinsed with fresh water and checked at regular intervals. It is recommended that trailers be serviced annually. The trailer and road base should never be immersed in water.
- Trailers and trolleys supplied by LaserPerformance are designed to transport the hull in the best possible manner to avoid damaging the hull. For instance, LaserPerformance does not recommend support hulls on rollers except on the keel line and only where there is a reinforced keelson. We also recommend gunwale hung trolleys for our smaller products. Hulls supported by a trolley bunk or wide strap must have the ability to drain water away from the hull. Trolley bunks padded with carpet or foam can cause blistering in the gel coat and changes to the hull color. Please do not transport your LaserPerformance product on a trailer or trolley that has not been specifically designed for the product. Hulls damaged through using an incorrectly designed or wrongly set up trailer or trolley are not covered under warranty.
- When securing your boat to a trailer for transport be very careful that ratchet straps and ropes are not over tightened and that there is sufficient padding under the strap or rope to prevent the hull/deck from being damaged through abrasion or pressure.
- Top covers must not be allowed to “flap” when driving at speed. This can abrade the surface of the hull and damage it. It is recommended if you are towing and plan to use your top cover that an under cover is fitted first to prevent cover flap damage to the top sides of the hull.
- Repairs to the polyethylene or GRP hulls should be undertaken by persons with the relevant equipment and skills. Contact LaserPerformance for advice.

Storage

- Your boat should always be tied down securely to the ground when not in use.
- UV light will cause fading to some components and fittings. A cover is recommended to reduce the UV degradation.
- Do not leave the rig under tension when not sailing or during storage.
- Care must be taken to support the hull adequately if storing on racking or similar. Any sustained point loading could permanently dent or distort the hull.
- Under covers for LaserPerformance products should be produced from a breathable or semi breathable fabric to allow moisture to evaporate away from the hull. This is essential to prevent damage to the hull skin. Also, the hull should never be left in the under cover wet or damp. A combination of moisture and heat over an extended period can also damage the hull. The under cover is designed to protect the hull when being transported and should be removed when the hull is being stored. Typical damage includes small bubbles or blisters, excessive print through of glass reinforcement, foam or wood and color change.
- Rudders and centerboards must never be stored wet in carry/combo bags. This can cause blistering, print through and warpage.
- All our GRP products are designed to be dry sailed. In other words stored on dry land. If you intend to leave your boat on a mooring for any length of time it is essential that you apply an osmosis barrier coat. LaserPerformance can recommend a suitable product.

On Water

- When wearing a trapeze harness, take particular care when climbing on to the centerboard and back into the boat after a capsize. The trapeze harness hook could easily damage the hull or deck.

On Water Towing

- Towing your LaserPerformance product at high speed (10 – 20 knots) behind a rib or power boat can seriously damage the hull. Boats damaged in this manner are not covered by the warranty. LaserPerformance recommends a maximum towing speed of 6 knots.

Owner Information

hull identification number

purchased from

date of purchase

contact name

phone #

address:

city / state / county

zip / postal code

hull color: sail #:

registration information (if applicable)

trailer vin #

license plate number

registration number

state / county registered in

insurance information

maintenance



LaserPerformance NORTH AMERICA

300 Highpoint Avenue
Portsmouth, Rhode Island 02871
t +1 800 966 SAIL
f +1 401 683 0990

LaserPerformance EUROPE

Station Works, Long Buckby
Northamptonshire NN6 7PF
United Kingdom
t +44 (0) 1327 841600
f +44 (0) 1327 841601

LaserPerformance ASIA

Room 3415
China Merchants Tower
Shun Tak Centre
No. 168-200 Connaught Road Central
Hong Kong
t +852 2902 2818
f +852 2587 7868

LaserPerformance AUSTRALIA

t +61 (0) 3 9016 4151

LaserPerformance MIDDLE EAST

T5 Middle East LLC
Dubai Investment Park
PO Box 38442
Dubai, UAE
t +971 (4) 885 7601

LASERPERFORMANCE.COM

All rights reserved. ©2008 LaserPerformance.
LaserPerformance and associated logos are
trademarks. Laser, SB3, Sunfish, and Dart
are trademarks used under license.
LaserPerformance reserves the right to make
design and/or specification changes to any
of their products as part of their continuous
development program.